



PHA 2000 PHB 3000 Exit Pad

Panic Hardware
in Contur Design

The modular DORMA Panic Hardware-system in Contur Design

Prior knowledge of how to open the escape door is not expected.

DANGER OF PANIC

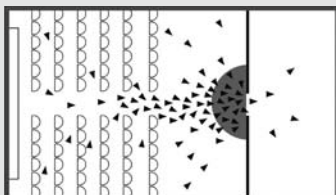

EN 1125

Panic exit devices operated
by a horizontal bar



Approval certification

The Panic Hardware products of the series DORMA PHA 2000 and PHB 3000 have been tested to and certified compliant with EN 1125. All products meet the requirements of Annex ZA to EN 1125 and are therefore qualified to bear the **CE** mark of conformity.

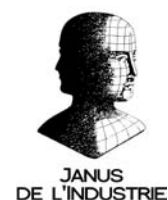

Prior knowledge of how to open the escape door is expected.

NO DANGER OF PANIC

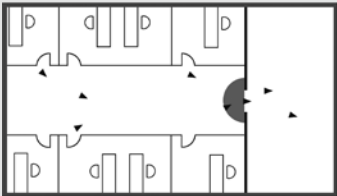

EN 179
Emergency escape devices with exit pad

Advanced, high-spec fittings for emergency exit doors

With this system, DORMA is able to offer a comprehensive range of high-quality panic hardware fittings with horizontal and vertical locking for doors in emergency exits and escape routes – applications in which safety, reliability and aesthetic attractiveness are indispensable requirements. DORMA's PHA and PHB products cover in full the hardware requirements that

arise in public-frequented facilities such as hospitals, universities and schools, concert halls, shopping malls, hotels and administrative buildings. Whether office suites or apartment blocks, in buildings where there is generally no public pedestrian traffic, the DORMA Exit Pad provides the ideal answer. For both series, the same external DORMA PHT fittings are used.



DORMA Exit Pad

Additional information

on many products can be viewed and retrieved at www.dorma.com

The abbreviated designations next to the computer symbol  indicate the search terms.

Contents

	Page
DORMA PHA 2000/PHB 3000	
Features and functions	4
DORMA PHA 2000	
Dimensions	6
DORMA PHA 2000	
Applications and fixing details	7
DORMA PHB 3000	
Dimensions	8
DORMA PHB 3000	
Applications and fixing details	9
DORMA PHA 2000/PHB 3000	
Components	10
DORMA Exit Pad	
Features and functions	16
DORMA Exit Pad	
Dimensions	18
DORMA Exit Pad	
Applications and fixing details	19
DORMA Exit Pad	
Components	20
DORMA PH	
Accessories	22
DORMA PH	
Accessories – Applications and fixing details	24
DORMA PHT external fittings	26

Approval certification

The emergency exit devices of the DORMA Exit Pad series are tested to and certified compliant with EN 179. All products meet the requirements of Annex ZA to EN 179 and are therefore qualified to bear the  mark of conformity.

Practical panic hardware for many door situations

With the series PHA 2000 crossbar and the series PHB 3000 pushbar combined with the universally applicable PHT external fittings, DORMA is able to offer a range suitable not only for narrow-stile doors but also timber and similar full-face doors.

The wide security latchbolt engages in a keeper that is normally mounted on the frame. This ensures that the latch is extremely easy to mount and that the door is also securely locked.

Benefits

For the trade

- Modular system for reduced storage costs
- Non-handed
- Universal use of PHT external fittings

For the installer

- Straightforward fixing
- Easy adjustment to different door widths and heights

For the architect/specifier

- For horizontal and vertical panic lock mechanisms
- External fitting with DORMA Premium lever handle or knob.
- Electrical functions for special applications

For the user

- Simple operation
- Excellent quality ensures long lifespan
- Universal electric strike

Data and features	PHA 2000			PHB 3000		
	1-point	2-point	3-point	1-point	2-point	3-point
Modular system	●	●	●	●	●	●
Standard (non-expandable)	–	●	–	●	–	–
Standard doors (single-leaf/double-leaf)	●	●	●	●	●	●
Fire and smoke check doors (single-leaf/double-leaf) F	●	●	●	●	●	●
Door width	≤ 1000 mm	●	●	●	●	●
	≤ 1300 mm	●	●	●	●	●
Door height	≤ 2270 mm		●		●	●
	≤ 3400 mm ¹⁾		●		●	●
Max. door leaf weight in kg	200	200	200	200	200	200
Non-handed design	●	●	●	●	●	●
Dogging device ²⁾	●	●	●	●	●	●
Security anti-thrust latch	for standard doors	–	–	–	–	–
	for fire and smoke check doors	●	●	●	●	●
Unlocking via electric strike	○	○	○	○	○	○
Monitoring switch on actuating bar	○	○	○	○	○	○
PHT external fittings						
For standard doors and fire and smoke check doors	●	●	●	●	●	●
For door leaf thicknesses up to 60 mm						
Extended handle spindle and bolts for door leaf thicknesses of 60 – 105 mm	○	○	○	○	○	○
Approved to EN 1125	●	●	●	●	●	●
CE mark for construction products	●	●	●	●	●	●

● = Yes – = No ○ = Option

¹⁾ Doors higher than 2500 mm lie outside the scope of EN 1125.

²⁾ Not for Fire and smoke check doors.

F Approval certification

The panic hardware products marked with an **F** are approved for use with fire and smoke check doors. Approval certification for the fire and smoke check

door in conjunction with the DORMA panic hardware product is additionally required in some countries – check local regulations.

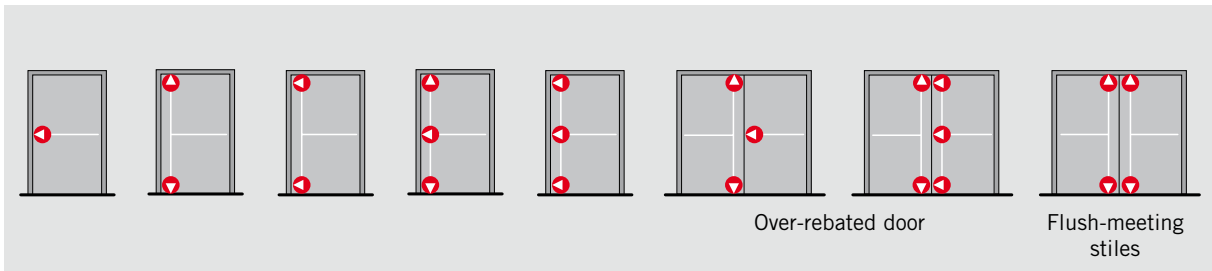

The modular panic hardware system

PHA 2000

PHB 3000



Single-point locking

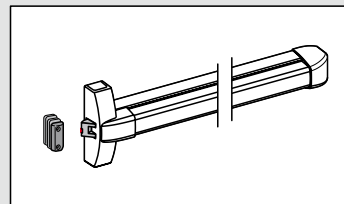
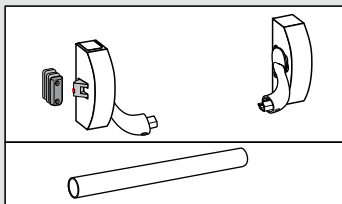

2/3-point locking

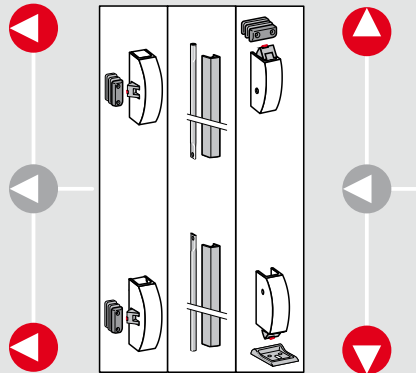

PHT

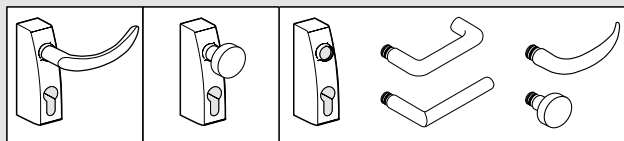

Security anti-thrust latch

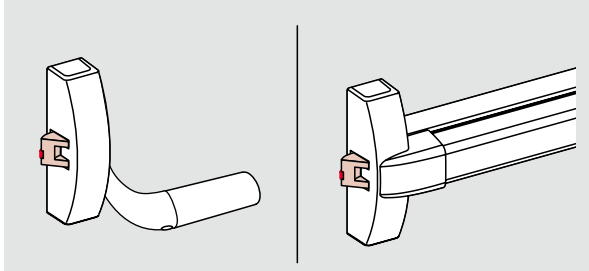

The security anti-thrust latch prevents the latch from being pushed back by unauthorised means when it is in the closed position.

Dogging device

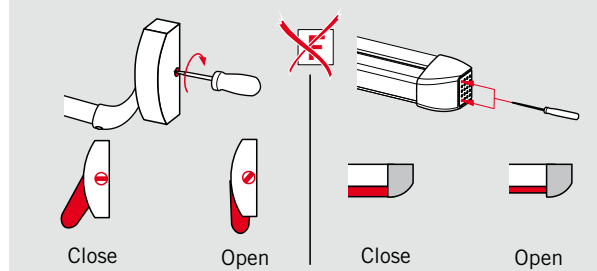

The dogging device serves to hold the latch in its retracted position so the door is freely accessible.

Single-point locking

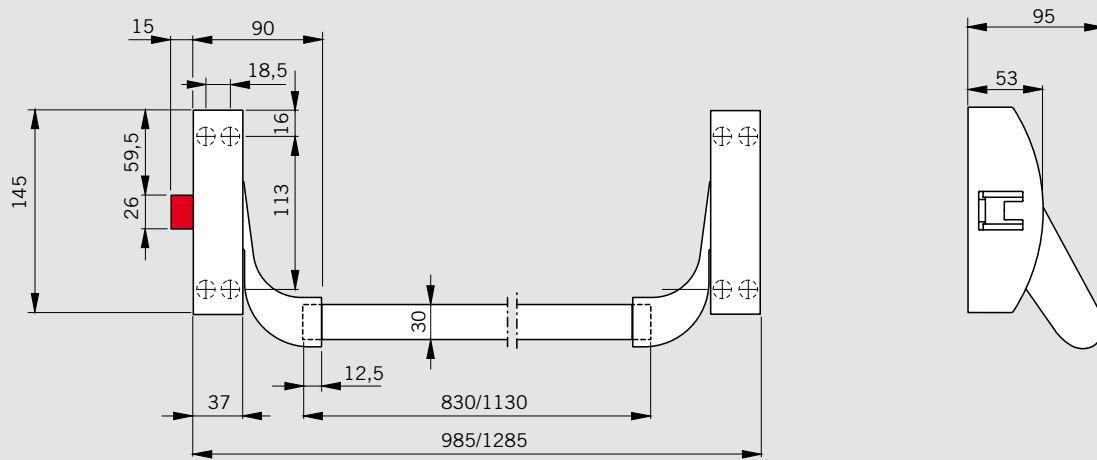

2/3-point locking

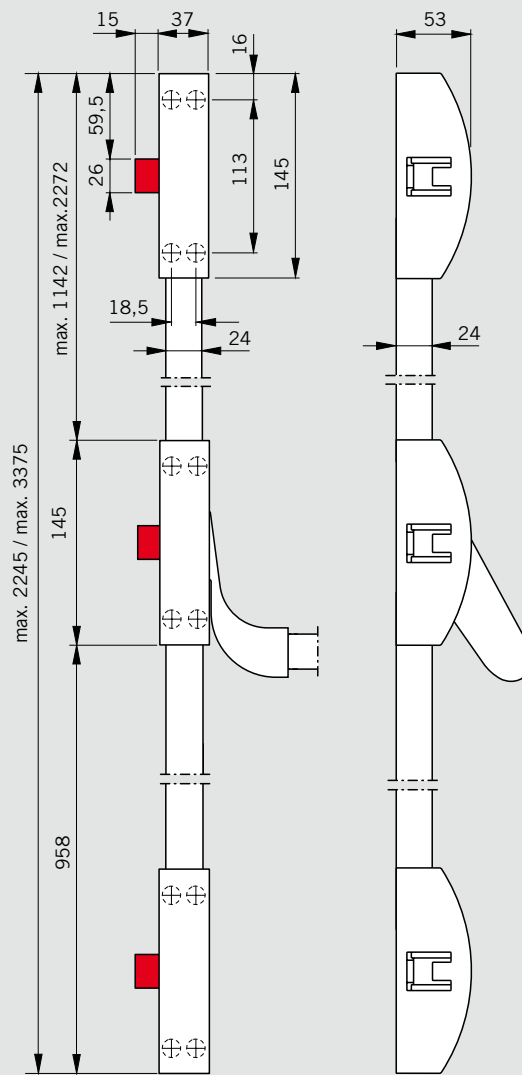
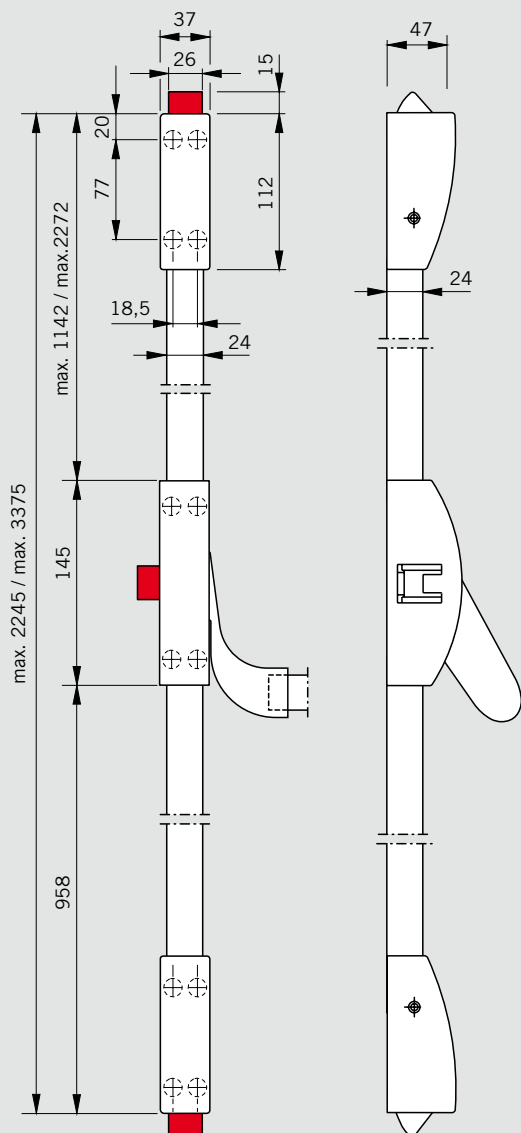

Applications and fixing details

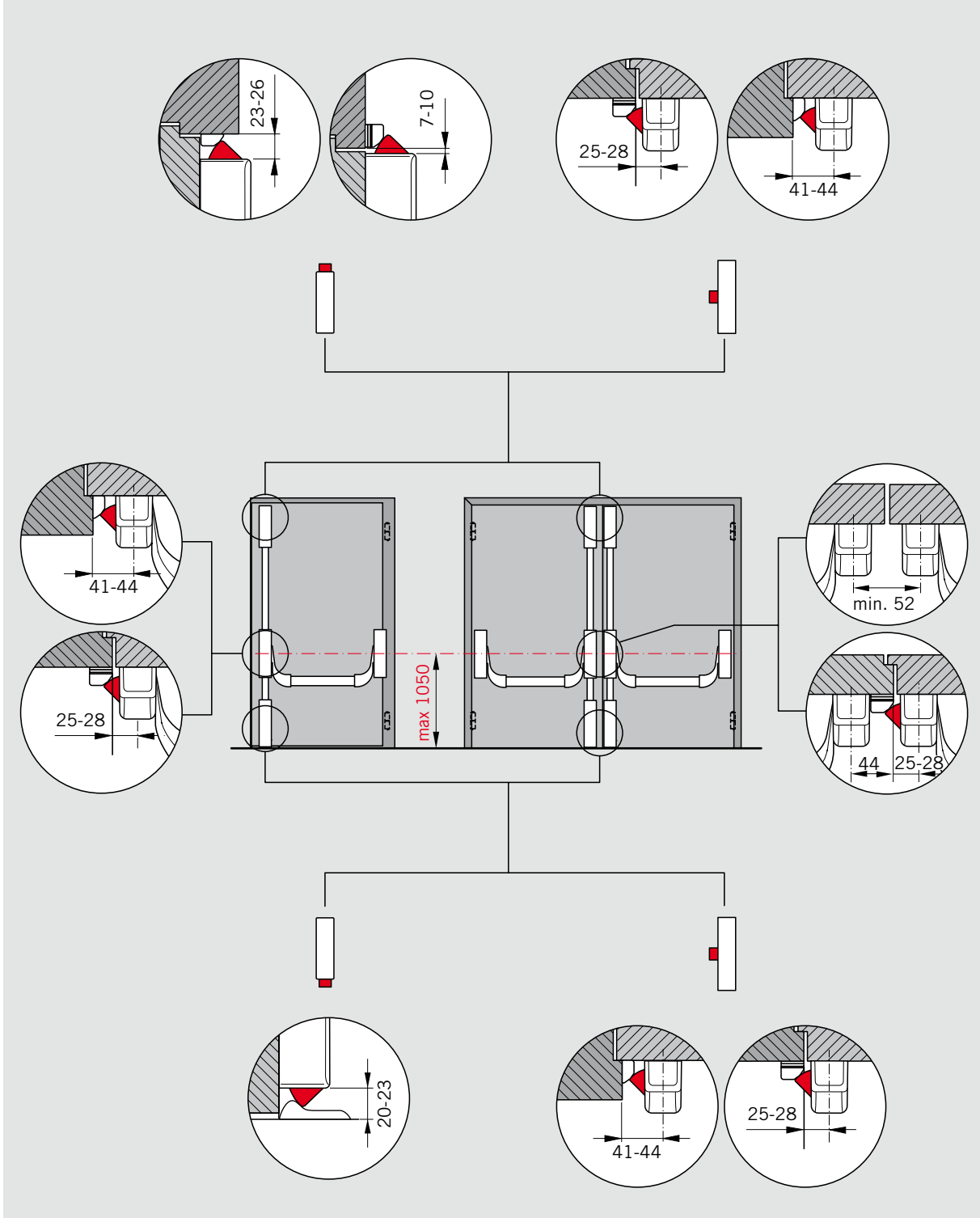

Note:

It may be the case that the exit device cannot be installed based on standard measurements where the door situation is extreme, e.g. with a door width

$X < 1000$ mm combined with a hinge offset $Y > 90$ mm. DORMA will be glad to provide you with installation suggestions on request.

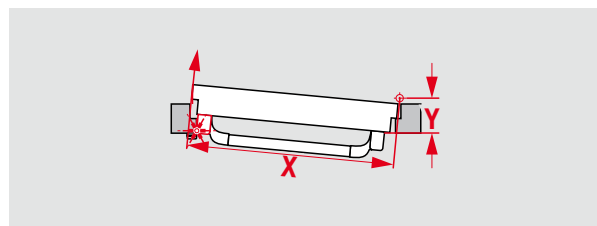

Single-point locking

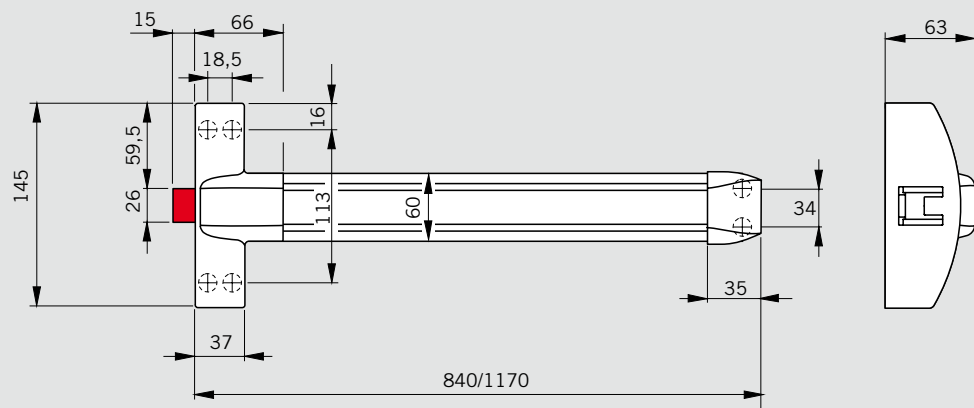

2/3-point locking

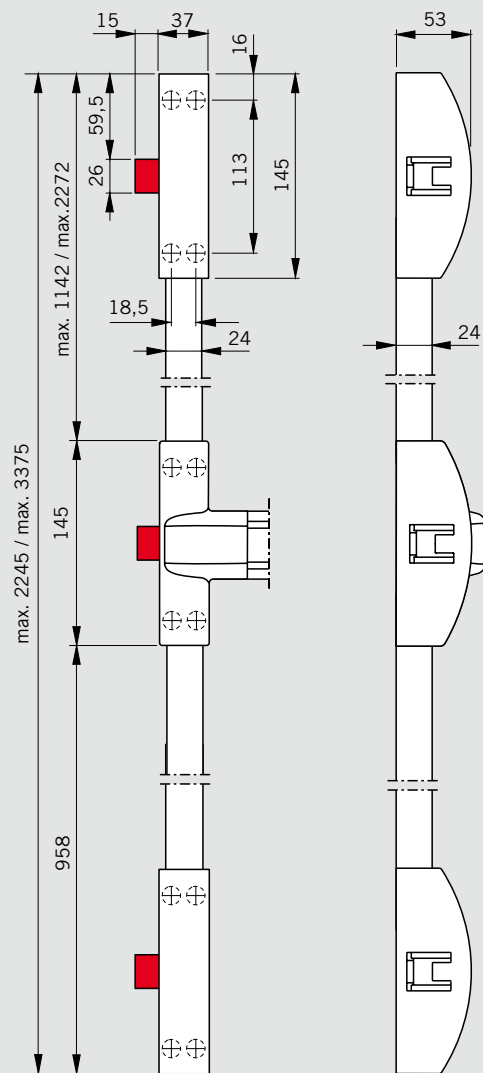
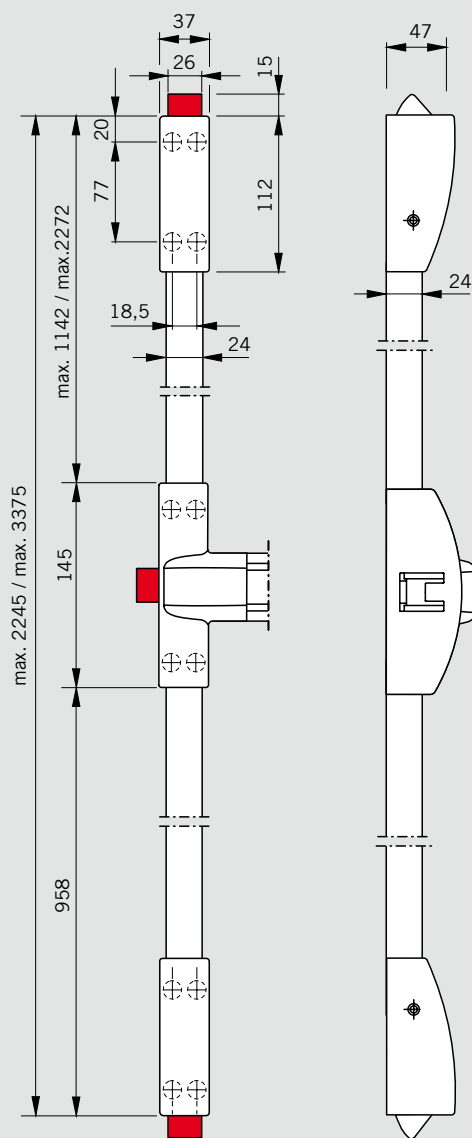

Applications and fixing details

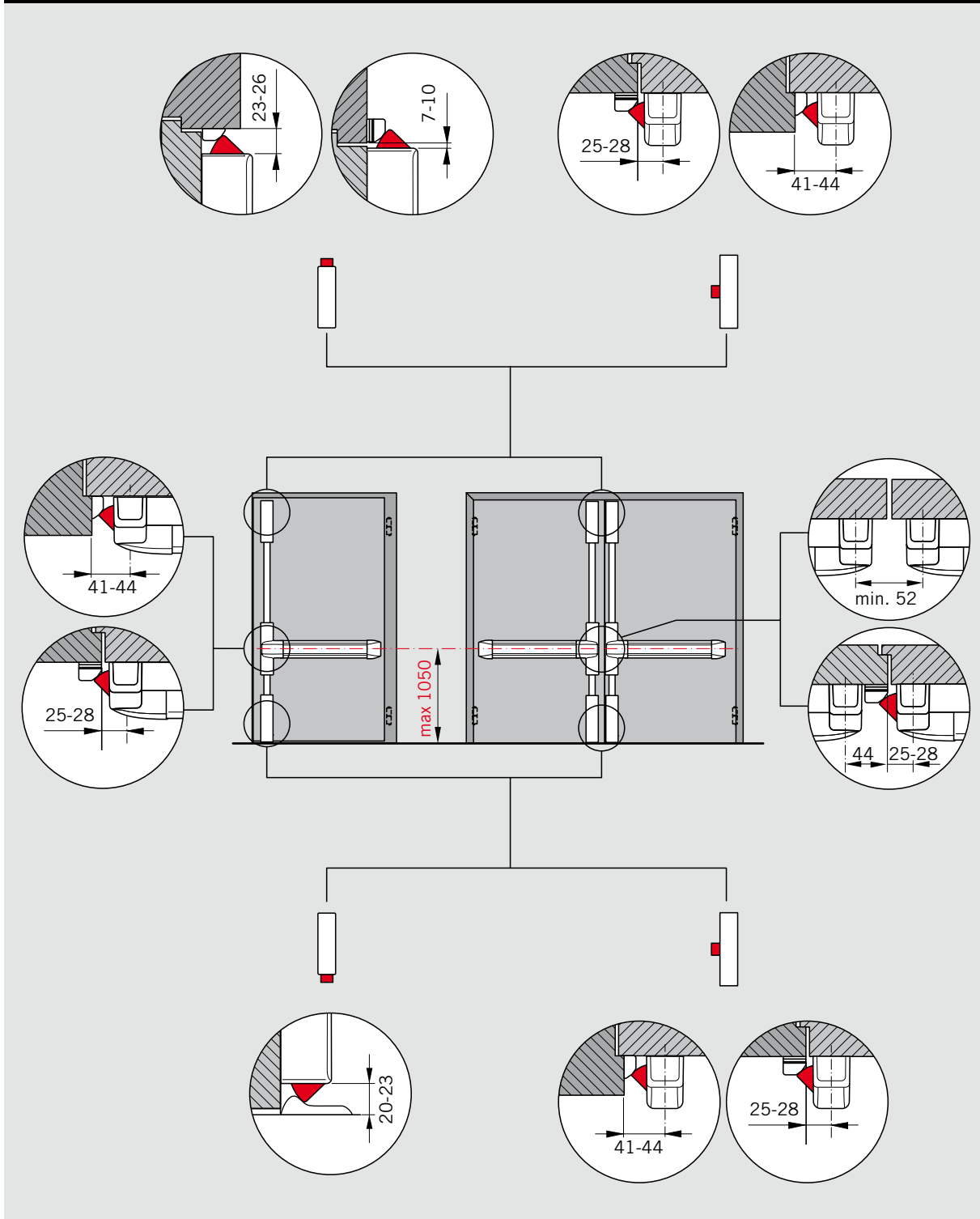

Note:

It may be the case that the exit device cannot be installed based on standard measurements where the door situation is extreme, e.g. with a door width

$X < 1000$ mm combined with a hinge offset $Y > 90$ mm. DORMA will be glad to provide you with installation suggestions on request.

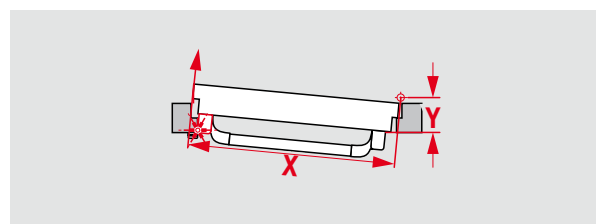

Components on single-leaf doors

Standard doors	Modular 2101	●	●	●	●	●
	Standard 2201		○	○		
	2104 / 05	●	●	●	●	●
	Modular 3102 / 03	●	●	●	●	●
	Standard 3101	○				
	PHX 04 / 05		●	●	●	●
PHX 02		●				
PHX 06			●			
Fire and smoke check doors F	Modular 2102	●	●	●	●	●
	Standard 2201		○	○		
	2104 / 05	●	●	●	●	●
	Modular 3104 / 05	●	●	●	●	●
	PHX 04 / 05		●	●	●	●
	PHX 03		●			
PHX 07			●			

F Approval certification

The DORMA panic hardware products of the series DORMA PHA 2000/PHB 3000 in the Contur design marked with the **F** symbol have been approved for use on fire and smoke check doors. In some countries, approval certification of the fire and smoke check doors to be used is additionally required.



The panic hardware products of the series DORMA PHA 2000/PHB 3000 in the Contur design carry the **CE** mark of conformity.

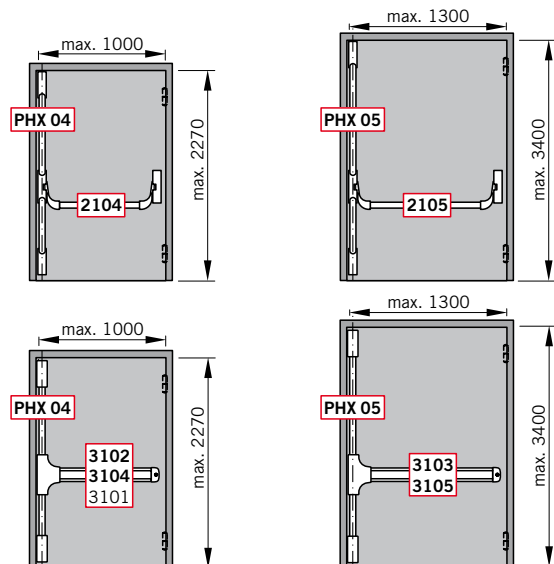

Components on double-leaf doors

Over-rebated door		Flush closing door					
Inactive leaf	Active leaf	Inactive leaf	Active leaf	Inactive leaf	Active leaf		
●	●	●	●	●	●	2101	Modular
○		○		○	○	2201	Standard
●	●	●	●	●	●	2104 / 05	
●	●	●	●	●	●	3102 / 03	Modular
	○					3101	Standard
●		●	●	●	●	PHX 04 / 05	
●		●	●	●	●	PHX 02 PHX 06	
●	●	●	●	●	●	2102	Modular
○		○		○	○	2201	Standard
●	●	●	●	●	●	2104 / 05	
●	●	●	●	●	●	3104 / 05	Modular
●		●	●	●	●	PHX 04 / 05	
●		●	●	●	●	PHX 03 PHX 07	

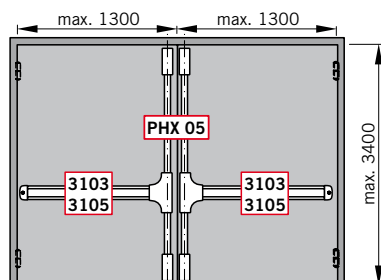
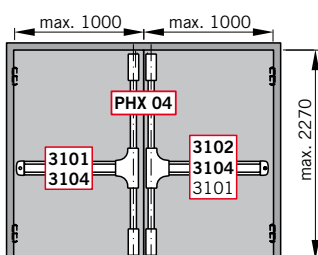
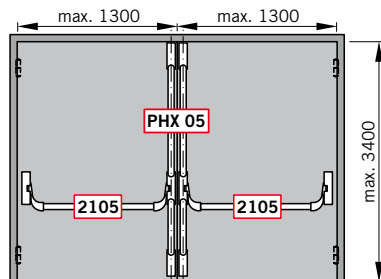
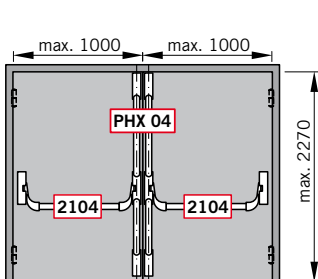

○ = Optional
For external fittings,
see page 26

Note:

According to EN 1125, the effective length of the operating bar has to be at least 60% of the door width. Doors higher than 2500 mm lie outside the scope of EN 1125.

Specification text

Order No. 35014 .. 

PHA 2000

Panic exit device tested in accordance with EN 1125, for door widths up to 1300 mm, door heights up to 2270 (in accordance with EN 1125) or 3400 mm; non-handed. Can be unlocked electrically via electric strike. All products of the PHA 2000 series carry the **CE** mark.

PHA 2101

Single-point locking, modular, for standard doors, without security anti-thrust latch, with dogging device. Zinc die-cast latch, zinc latch keeper with spacer plates, plastic mounting backplate.

- silver finish
- black
- white

..21011001
..21011002
..21011010  PHA 2101

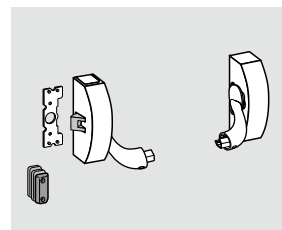

PHA 2102 

Single-point locking, modular, for fire and smoke check doors, with security anti-thrust latch and dogging device. Steel latch, steel latch keeper with spacer plates, plastic mounting backplate.

- silver finish
- black
- white
- stainless steel finish

..21021001
..21021002
..21021010
..21021004  PHA 2102

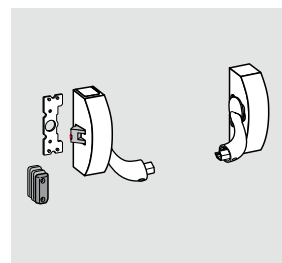

PHA 2201

Two-point locking only, with dogging device. Plastic mounting backplate.

- silver finish
- black
- white

..22011001
..22011002
..22011010  PHA 2201

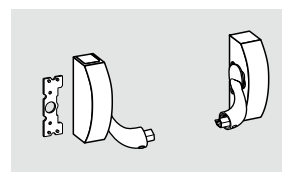

PHA 2104

Connecting rod 830 mm (for door widths up to 1000 mm)

- silver finish
- red
- black
- white

..21041001
..21041002
..21041019
..21041010  PHA 2104

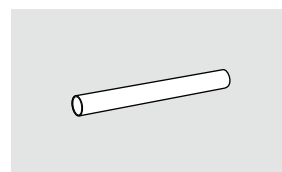

PHA 2105

Connecting rod 1130 mm (for door widths up to 1300 mm)

- silver finish
- red
- black
- white
- stainless steel finish

..21051001
..21051002
..21051019
..21051010
..21051004  PHA 2105

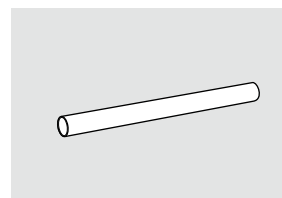

See page 22 for accessories such as adjustable keepers, electric strikes or micro switches for signal actuation.

Specification text
Order No. 35014 .. 
PHA 3000

Panic exit device tested in accordance with EN 1125, for door widths up to 1300 mm, door heights up to 2270 mm (in accordance with EN 1125) or 3400 mm, non-handed. Can be unlocked electrically via electric strike. All products of the PHB 3000 series carry the **CE** mark.

PHB 3101

Single-point locking, standard, for standard doors with a door width up to 1000 mm, without security anti-thrust latch, with dogging device. Zinc die-cast latch, steel latch keeper with spacer plates.

- silver finish
- white

..31011001
 ..31011010  PHB 3101

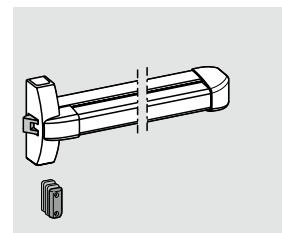
PHB 3102

Single-point locking, modular, for standard doors with a door width up to 1000 mm, without security anti-thrust latch, with dogging device. Zinc die-cast latch, steel latch keeper with spacer plates.

- silver finish
- white

..31021001
 ..31021010  PHB 3102

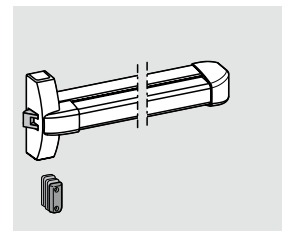
PHB 3103

Single-point locking, modular, for standard doors with a door width up to 1300 mm, without security anti-thrust latch, with dogging device. Zinc die-cast latch, steel latch keeper with spacer plates.

- silver finish
- white

..31031001
 ..31031010  PHB 3103

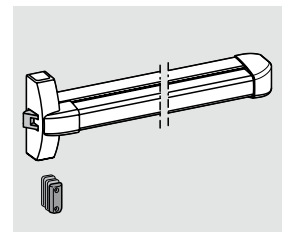
PHB 3104 F

Single-point locking, modular, for fire and smoke check doors with a door width up to 1000 mm, with security anti-thrust latch and dogging device. Steel latch, steel latch keeper with spacer plates.

- silver finish
- white
- stainless steel finish

..31041001
 ..31041010
 ..31041004  PHB 3104

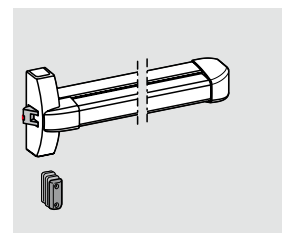
PHB 3105 F

Single-point locking, modular, for fire and smoke check doors with a door width up to 1300 mm, with security anti-thrust latch and dogging device. Steel latch, steel latch keeper with spacer plates.

- silver finish
- white
- stainless steel finish

..31051001
 ..31051010
 ..31051004  PHB 3105

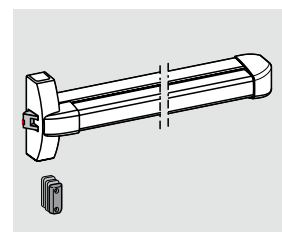

Specification text

Order No. 35014 .. 

PHX 02

Top and bottom lock combination, without security anti-thrust latch. Zinc die-cast latch, zinc top latch keeper with spacer plates, steel bottom latch keeper.

- silver finish
- black
- white

- ..22021001
- ..22021002
- ..22021010  PHX 02

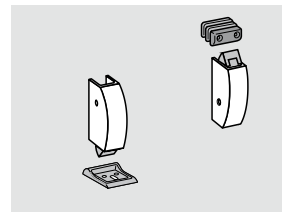

PHX 03 F

Top and bottom lock combination, for fire and smoke check doors, with security anti-thrust latch.

Steel latch, steel top latch keeper with spacer plates, steel bottom latch keeper.

- silver finish
- black
- white
- stainless steel finish

- ..22031001
- ..22031002
- ..22031010
- ..22031004  PHX 03

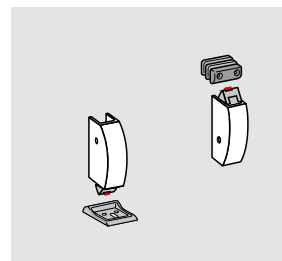

PHX 06

OTop and bottom locking combination with lateral latch, without security anti-thrust latch.

Die-cast zinc latch, steel latch keepers with spacer plates.

- silver finish
- black
- white

- ..22061001
- ..22061002
- ..22061010  PHX 06

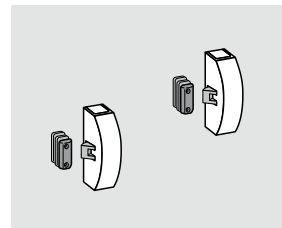

PHX 07 F

Top and bottom locking combination with lateral latch, for fire and smoke check doors, with security anti-thrust latch.

Steel latch, steel latch keepers with spacer plates.

- silver finish
- black
- white
- stainless steel finish

- ..22071001
- ..22071002
- ..22071010
- ..22071004  PHX 07

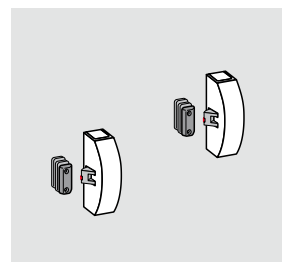

Specification text

Order No. 35014 .. 

PHX 04 

Connecting rod set with cover for door heights up to 2270 mm.

Steel latch keeper with spacer plates for double doors.

- silver finish
- black
- white
- stainless steel finish

- ..22041001
- ..22041002
- ..22041010
- ..22041004  PHX 04

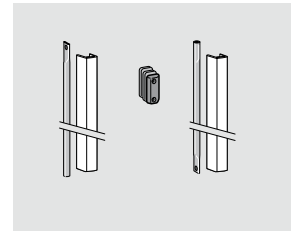

PHX 05 

Connecting rod set with cover for door heights up to 3400 mm.

Steel latch keeper with spacer plates for double doors.

- silver finish
- black
- white
- stainless steel finish

- ..22051001
- ..22051002
- ..22051010
- ..22051004  PHX 05

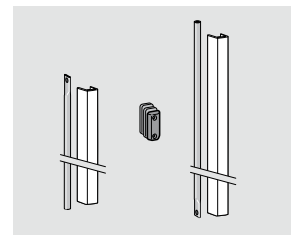

Emergency exits protected in accordance with EN 179

The fittings of the DORMA Exit Pad series are high-quality emergency exit devices for doors in escape routes and can be combined with the components of the PHA 2000/PHB 3000 series. They are used in buildings with no public pedestrian traffic. It is expected that people using the building are familiar with the exits

and their fittings, avoiding the likelihood of a panic situation developing. All products of the DORMA Exit Pad series have been tested to and certified compliant with EN 179. They correspond to the requirements of Annex ZA to EN 179 and can therefore carry the **CE** mark of conformity.

Benefits

For the trade

- All-in-one packaging for easy stocking
- Non-handed
- Universal use of PHT external fittings

For the installer

- Straightforward fixing
- Easy adjustment to different door widths and heights

For the architect/specifier

- High-quality appearance with no visible fixings.
- Connecting rods with metal covers.
- External fitting with DORMA Premium lever handle or knob.

For the user

- Simple operation
- Excellent quality ensures long lifespan

Data and features	Exit Pad ¹⁾	
	1-point	2-point
Standard doors (single-leaf/double-leaf)	●	●
Fire and smoke check doors (single-leaf/double-leaf) [E]	●	●
Door width ≤ 1300 mm	●	–
Door height ≤ 2270 mm	–	●
Max. door leaf weight (in kg)	200	200
Non-handed	●	●
Security anti-thrust latch	for standard doors	–
	for fire and smoke check doors	●
Unlocking via electric strike	○	○
External fittings PHT		
For standard doors and fire and smoke check doors	●	●
For door leaf thicknesses up to 60 mm		
Extended handle spindle and bolts for door leaf thicknesses of 60 – 105 mm	○	○
Approved to EN 179	●	●
CE mark for construction products	●	●

● = Yes – = No ○ = Option

¹⁾To achieve a three-point locking system, the Exit Pad can be used as a modular single-point locking device in combination with the PHX components from the PHA 2000/PHB 3000 series.

In conjunction with PHX 05 door height max. 3400 mm (Doors higher than 2500 mm lie outside the scope of EN 179).

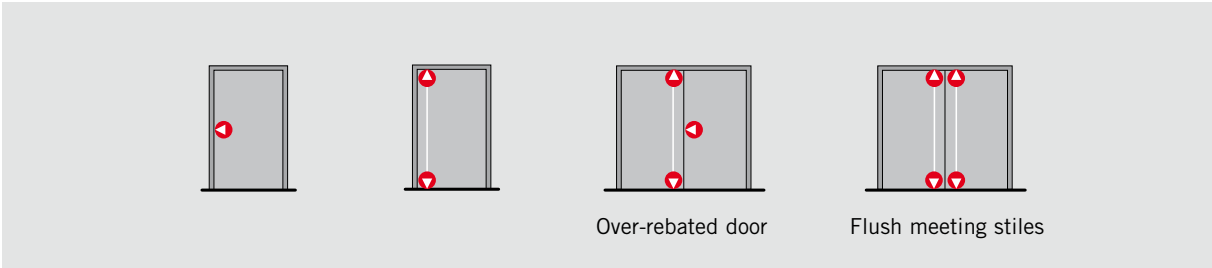

Exit Pad

Single-point locking

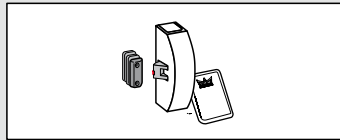

Two-point locking

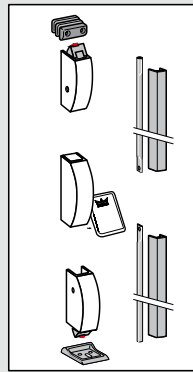

+
PHT

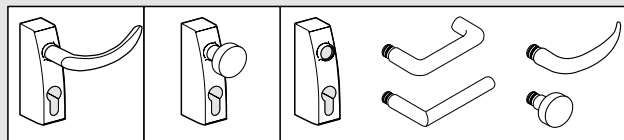

Security anti-thrust latch

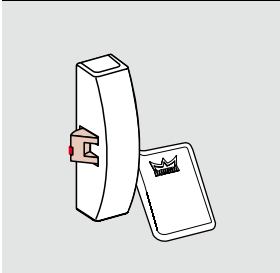

The security anti-thrust latch prevents the latch from being pushed back by unauthorised means when it is in the closed position.

Single-point locking

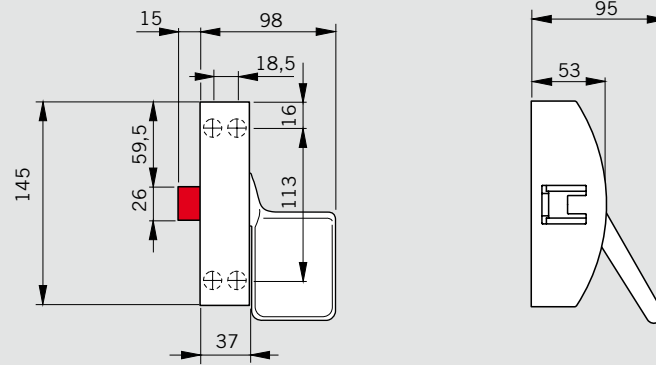

Two-point locking

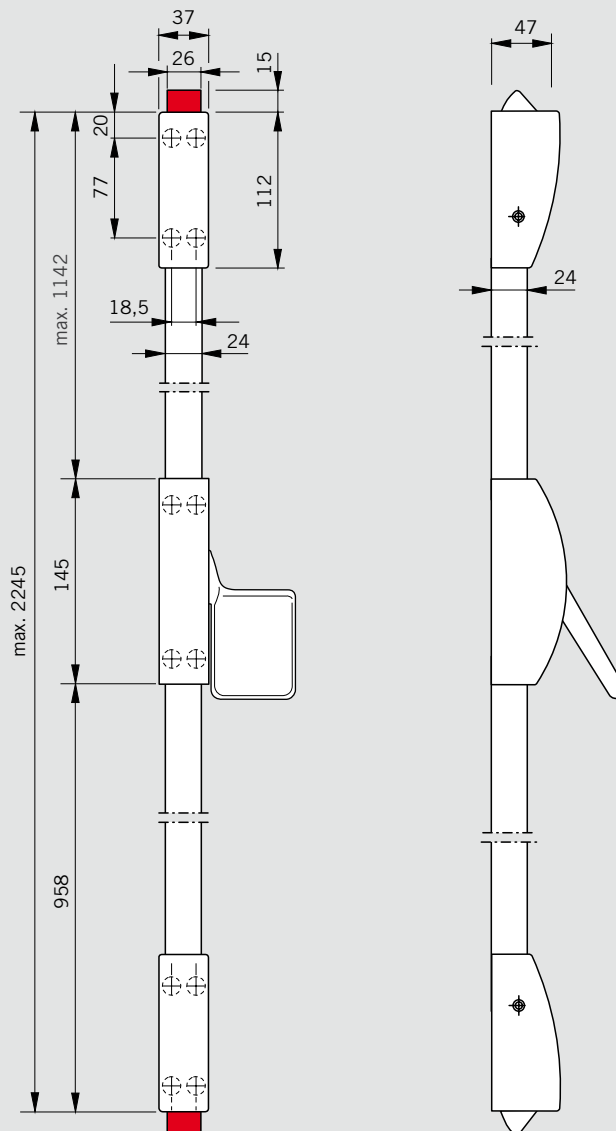

Applications and fixing details

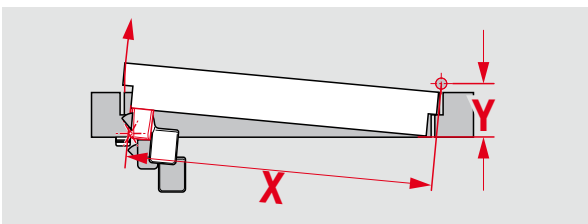
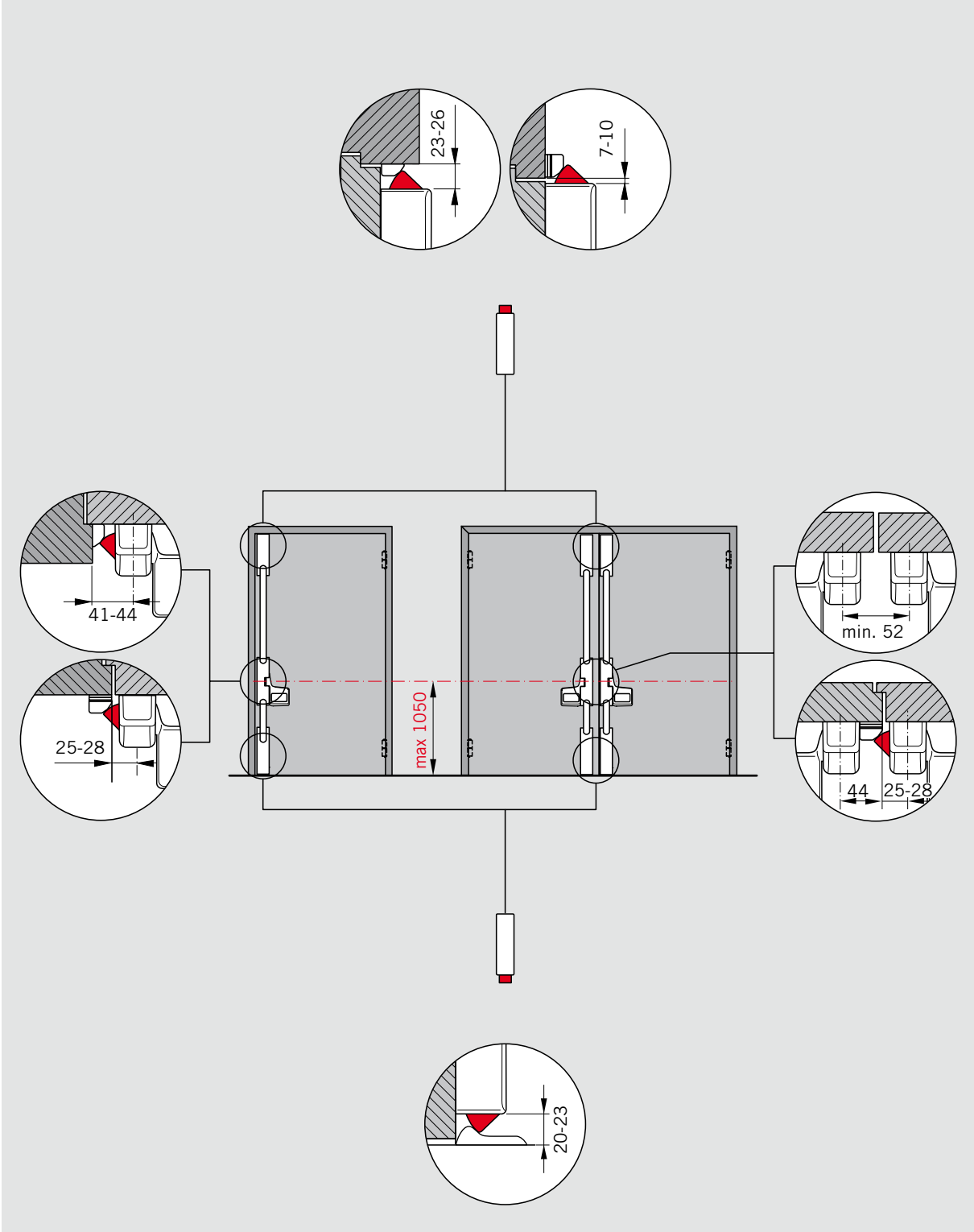

Note:

It may be the case that the exit device cannot be installed based on standard measurements where the door situation is extreme, e.g. with a door width

$X < 1000$ mm combined with a hinge offset $Y > 90$ mm. DORMA will be glad to provide you with installation suggestions on request.

Specification text

Order No. 35014 .. 

Exit Pad

Emergency exit device tested and approved to EN 179, non-handed. Can be unlocked electrically via electric strike. All products of the Exit Pad series carry the **CE** mark of conformity.

Exit Pad

Single-point locking, modular, for all standard doors, without security anti-thrust latch. Zinc die-cast latch, zinc latch keeper, with spacer plates, plastic mounting bracket.

- silver finish

..21111001  Exit Pad

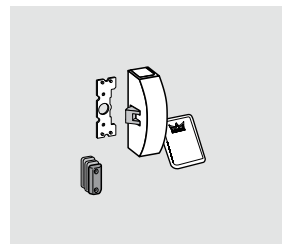

Exit Pad F 

Single-point locking, modular, for fire and smoke check doors, with security anti-thrust latch.

Steel latch, steel latch keeper with spacer plates, plastic mounting bracket.

- silver finish
- white
- stainless steel finish

..21121001
..21121010
..21121004  Exit Pad

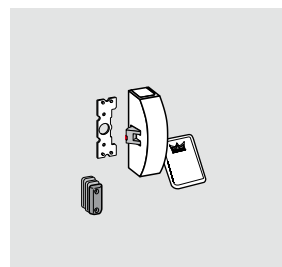

Exit Pad 2P

Two-point locking for standard doors, door heights up to 2270 mm, without security anti-thrust latch. Zinc die-cast latch, zinc latch keeper with spacer plates, plastic mounting bracket.

- silver finish

..22111001  Exit Pad

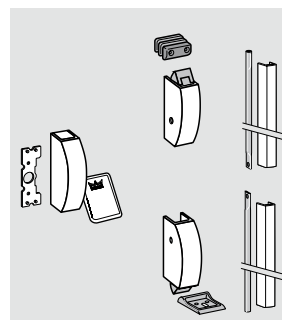

Exit Pad F 2P 

Two-point locking, for fire and smoke check doors, door heights up to 2270 mm, with security anti-thrust latch.

Steel latch, steel latch keeper with spacer plates, plastic mounting backplate.

- silver finish
- white
- stainless steel finish

..22121001
..22121010
..22121004  Exit Pad

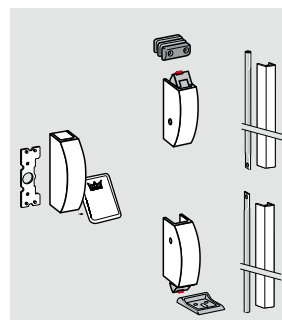

Note

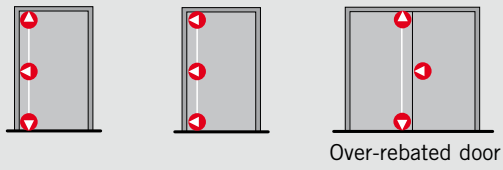

To achieve three-point locking, the modular single-point locking Exit Pad can be used in conjunction with the components of the PHA 2000/PHB 3000 series.

PHX 02

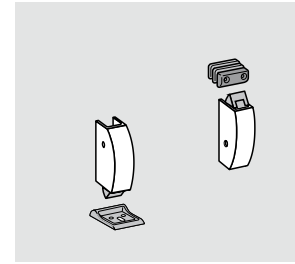

PHX 03

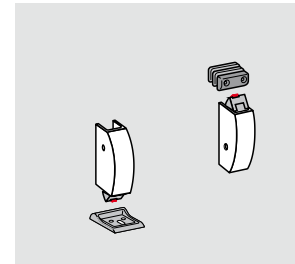

PHX 06

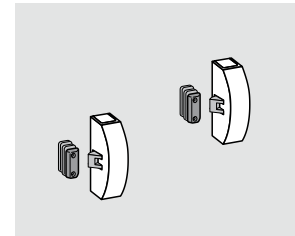

PHX 07

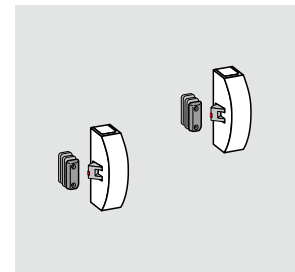

PHX 04

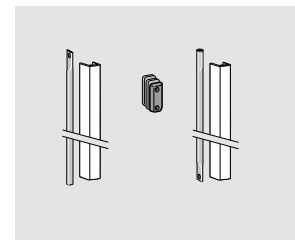

PHX 05

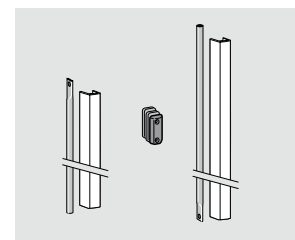

Specification text

Order No. 35014 .. 

PHX 50 Electric Strike

In combination with PHA/PHB for use on standard doors with a rebate overlap of up to 24 mm.

Zinc die-cast latch engaging device. 12 V AC, 50 Hz, 15 W

- silver finish
- black
- white
- stainless steel finish

- ..24501001
- ..24501002
- ..24501010  PHX
- ..24501004 Accessories

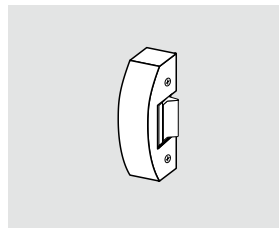

PHX 21 Adjustable Keeper

For standard aluminium narrow-stile doors, single- and double-leaf, flush or over-rebated (0–11 mm)

Zinc die-cast latch (in packs of 5)

- silver finish
- black
- white
- stainless steel finish

- ..24210101
- ..24210102
- ..24210110  PHX
- ..24210104 Accessories

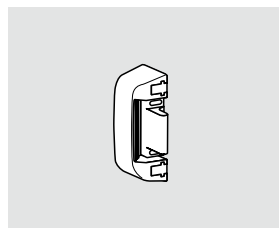

PHX 22 Adjustable Keeper

For standard PVC profile doors, single and double leaf, over-rebated (14–24 mm)

Zinc die-cast latch (in packs of 5)

- silver finish
- black
- white
- stainless steel finish

- ..24220101
- ..24220102
- ..24220110  PHX
- ..24220104 Accessories

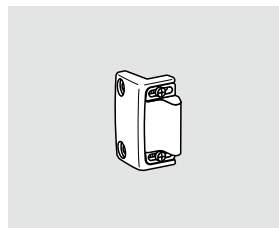

PHA Microswitch

For actuation of visual or audible signals.
Contact rating: max. 48 V DC, max. 3 A

- ..25200060  PHA
- Accessories

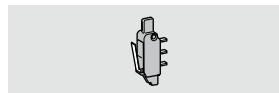

PHB Microswitch

For actuation of visual or audible signals.
Contact rating: max. 48 V DC, max. 3 A

- ..35201061  PHB
- Accessories



PHX Mounting Backplate

Steel, galvanised (in packs of 10)
for factory pre-installation to simplify field installation

- ..25200050  PHX
- Accessories

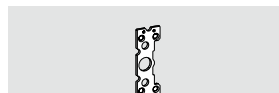

PHX Mounting Backplate

Steel, galvanised (in packs of 10)
for factory pre-installation to simplify field installation

- ..25200051  PHX
- Accessories



Specification text

Order No. 35014 .. 

Accessories for glass doors

PHA Glass Kit A

Installation set for PHA 2000
Single-point, without external hardware

..24011004  PHA

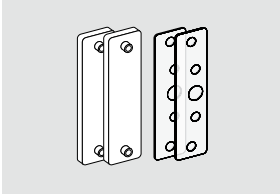

PHA Glass Kit B

Installation set for LH (ISO 6), for PHA 2000
Single-point, with external fitting

..24021004  PHA

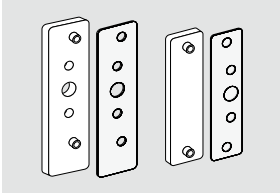

PHA Glass Kit C

Installation set for RH (ISO 5), for PHA 2000
Single-point, with external fitting

..24031004  PHA

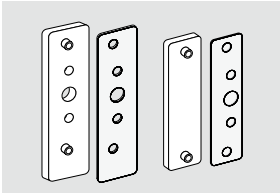

PHA Glass Kit F

Mounting backplate for steel latch keepers,
for single and double-leaf doors

..24061004  PHA

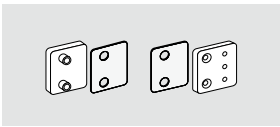

PHX 50 – Electric Strike

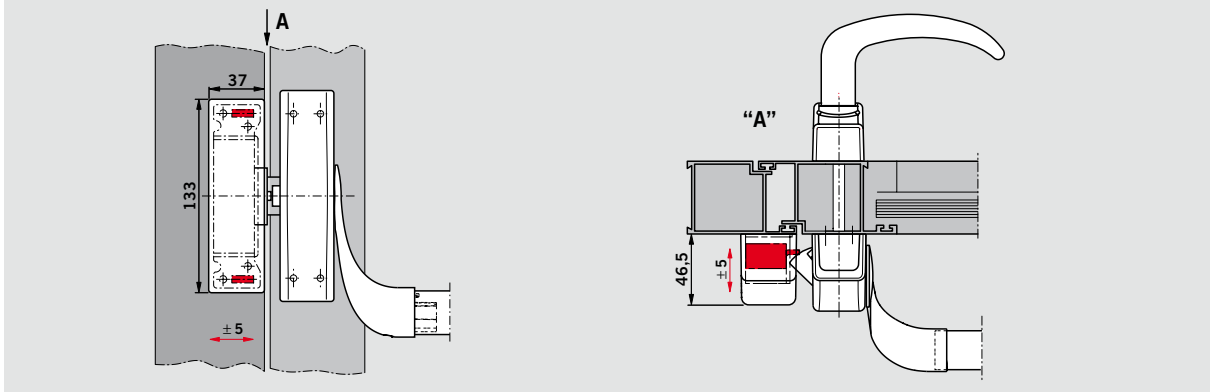

Application example for PHX 50 with PHA 2000 in the Contur design on an aluminium framed door

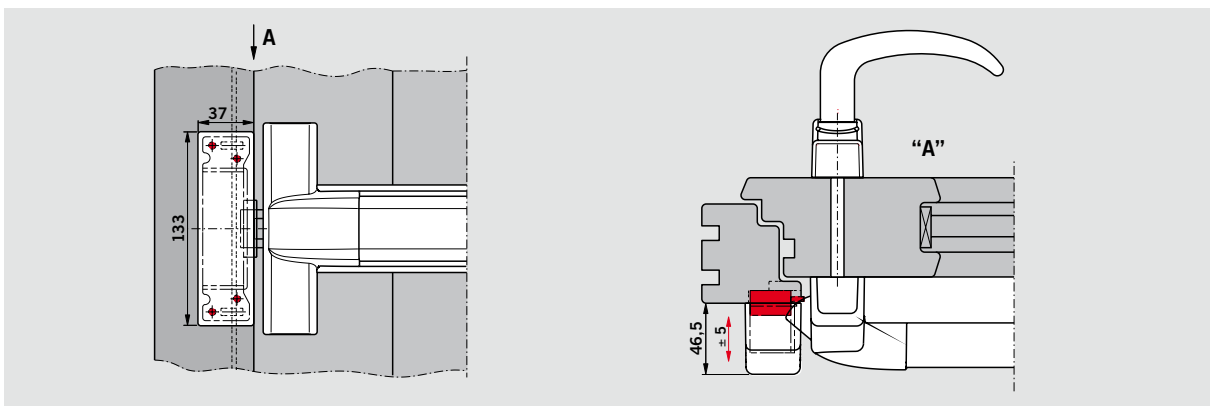

Application example for PHX 50 with PHB 3000 in the Contur design on an aluminium framed door

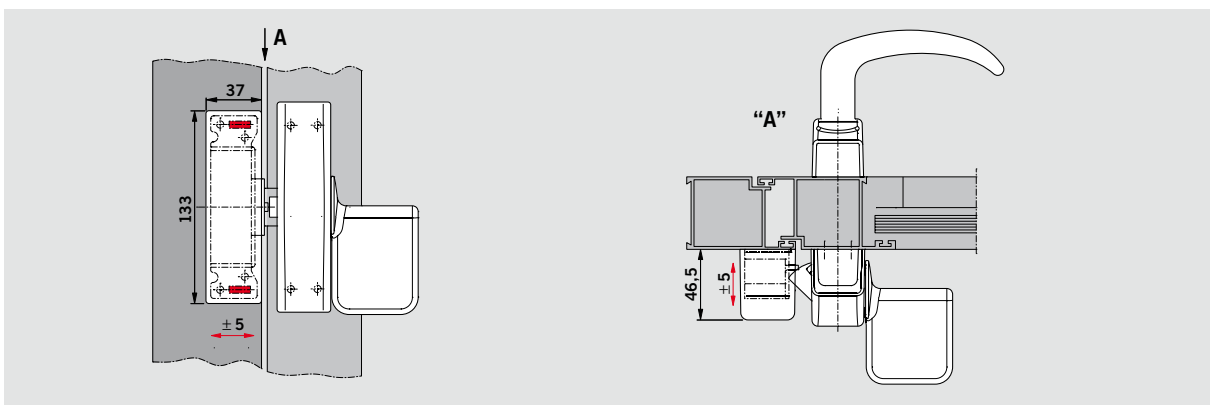

Application example for PHX 50 with Exit Pad in the Contur design on an aluminium framed door

PHX 21 – Adjustable Latch Keeper for Aluminium Narrow-Stile Doors

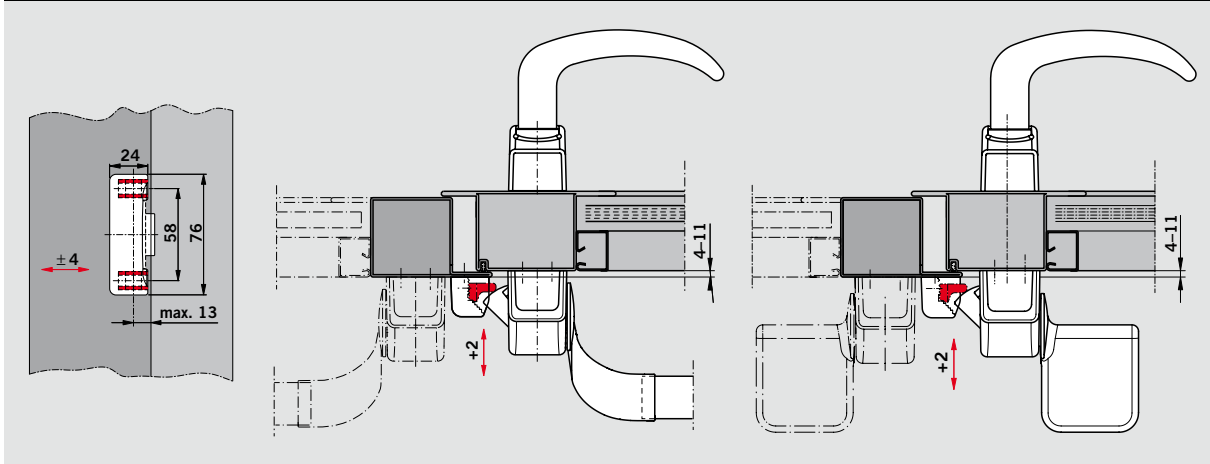

Application example of a PHX 21 on an over-rebated door, universal applicability for single-leaf and double-leaf doors

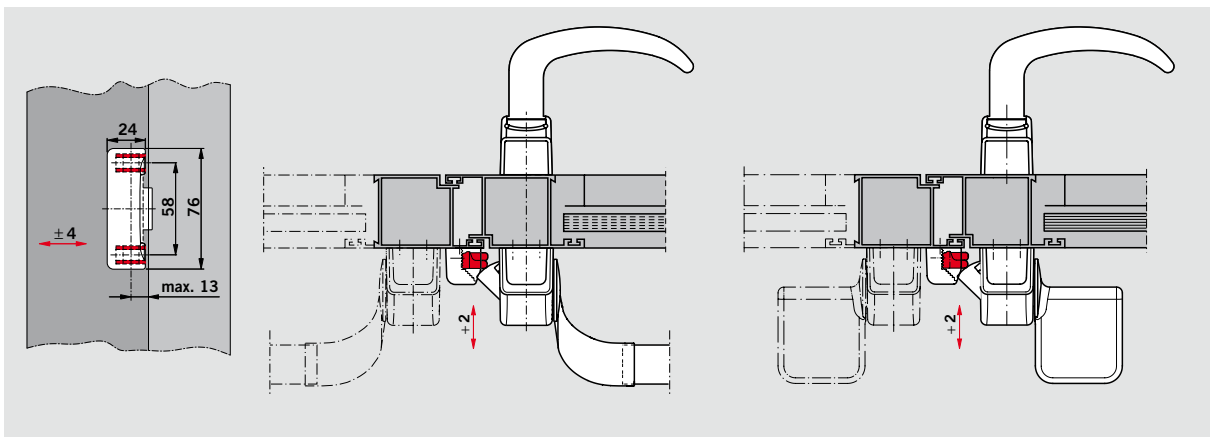

Application example of a PHX 21 on a door with flush meeting stiles, universal applicability for single-leaf and double-leaf doors

PHX 22 – Adjustable Latch Keeper for PVC Profile Doors

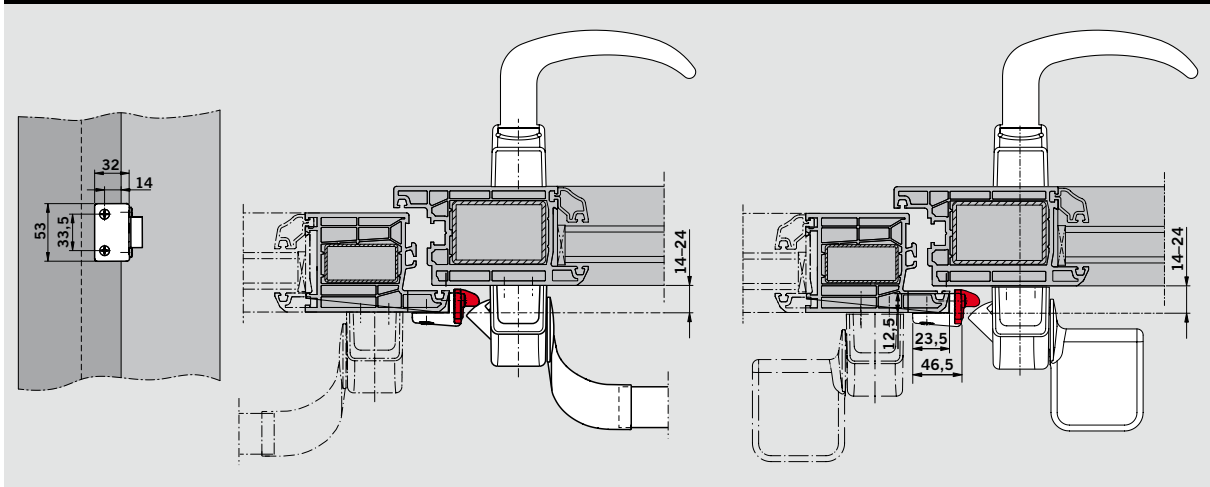

Application example of a PHX 22 on an over-rebated door, universal applicability for single-leaf and double-leaf doors

Specification text

Order No. 35014 .. 

PHT

External fitting with lever handle or knob, suitable for use with PHA 2000 and PHB 3000. All PHT external fittings are non-handed and carry the  mark.

PHT 01

External fitting with DORMA Premium lever handle, for standard doors with a leaf thickness of up to 60 mm, prepared for installation of a Europrofile single cylinder. With lever handle spindle and two cylinder fixing bolts.

- silver finish
- black
- white

..39011001
..39011002
..39011010  PHT 01

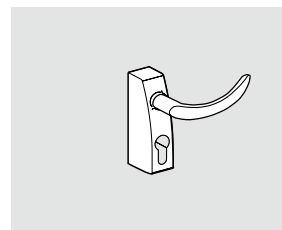



PHT 03

External fitting with DORMA Premium lever handle, for standard doors with a leaf thickness up to 60 mm, non-lockable. With lever handle spindle

- silver finish
- black
- white

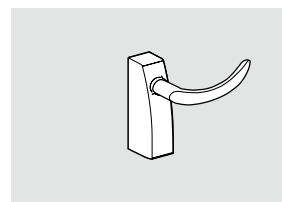
..39031001
..39031002
..39031010  PHT 03



PHT 05 

External fitting with DORMA Premium lever handle for fire and smoke check doors with a leaf thickness up to 60 mm. With integrated ring gasket. Prepared for installation of a Europrofile single cylinder. With lever handle spindle and two cylinder fixing bolts.

- silver finish
- black
- white
- stainless steel finish

..39051001
..39051002
..39051010
..39051004  PHT 05

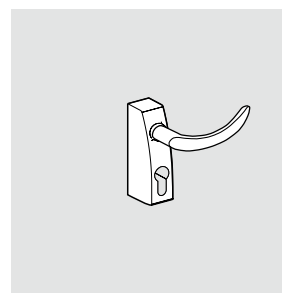

PHT 06

External fitting with knob, for standard doors with a door thickness up to 60 mm, prepared for the installation of a Europrofile single cylinder. With lever handle spindle and two cylinder fixing bolts.

- silver finish
- black
- white

..39061001
..39061002
..39061010  PHT 06

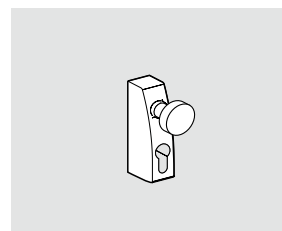

PHT 07 

External fitting, suitable for combination with DORMA Premium lever handles or knobs for fire and smoke check doors. With lever handle spindle and two cylinder fixing bolts.

- silver finish
- black
- white
- stainless steel finish

..39071001
..39071002
..39071010
..39071004  PHT 07

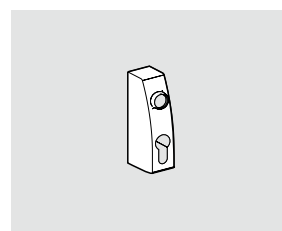

Specification text

Order No. 35014 ..

PHT S 05 Extended Spindle
 8 mm square, incl. fixing screws
 for door leaf thicknesses of 60 – 105 mm.

..39200050 PHT
 Accessories

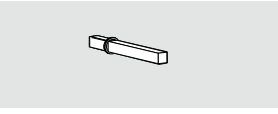

F Gasket Set for external fitting
 and **PHA / PHB** exit devices fixed to
 fire and smoke check doors.

..39200060 PHT
 Accessories

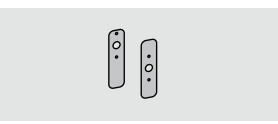

DORMA TL-Z 03
 Single Europrofile cylinder with 3 keys,
 for PHT 01, 05, 06, 07

56510300

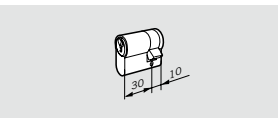

PHT – External Fitting

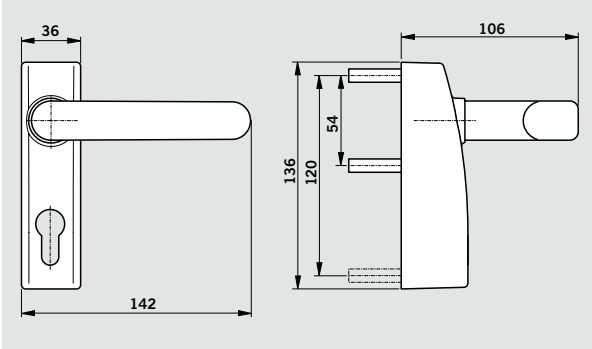

PHT 01, 03, 05 – External fitting with lever handle

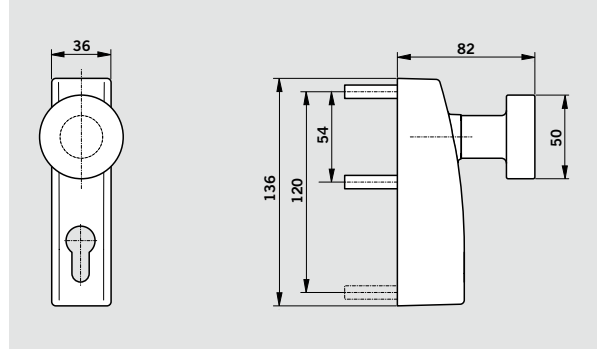

PHT 06 – External fitting with knob

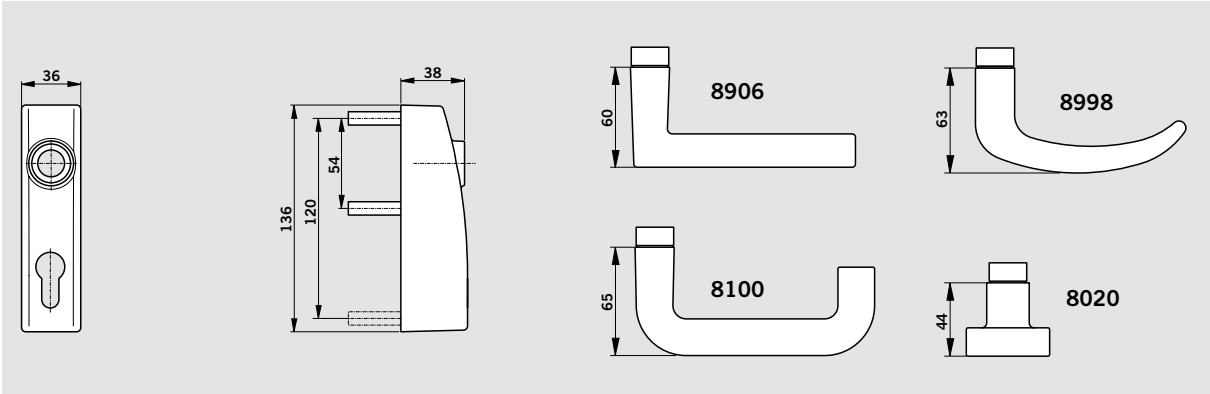

PHT 07 – External fitting, modular

F

When using the DORMA PHT external fitting in conjunction with the PHA/PHB panic hardware series or Exit Pad on fire and smoke check doors, it must be ensured that the appropriate set of gaskets is used.

CE

The panic hardware products of the DORMA PHT series carry the **CE** mark of conformity.

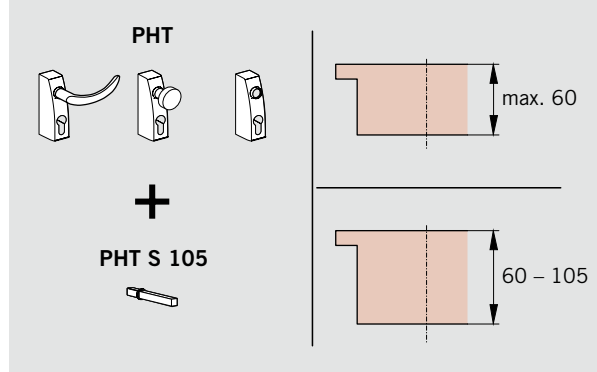



Door Control



Automatic



**Glass Fittings
and Accessories**



**Security/Time
and Access (STA)**



Movable Walls

Door Control Division worldwide

Central Europe

DORMA GmbH + Co. KG
DORMA Platz 1
D-58256 Ennepetal
Tel. +49 2333 793-0
Fax +49 2333 793-495

Australasia

DORMA Door Controls Pty. Ltd.
46-52, Abbott Road
Hallam/Victoria 3803
Australia
Tel. +61 3979 63555
Fax +61 3979 63955

China/Hong Kong

DORMA Door Controls
(Suzhou) Co. Ltd.
No. 9, Hong Feng Road
Suzhou Singapore Industrial Park
Suzhou, 215021
P.R. of China
Tel. +86 512 67612481
Fax +86 512 67614582

DORMA Door Controls Pte. Ltd.
Room 701, Technology Plaza
651 King's Road
North Point
Hong Kong
Tel. +852 25034632
Fax +852 28875370

Emerging Markets

DORMA GmbH + Co. KG
DORMA Platz 1
D-58256 Ennepetal
Tel. +49 2333 793-0
Fax +49 2333 793-495

DORMA Door Controls (Pty.) Ltd.
Kings Court
4A Mineral Crescent
ZA-2000 Crown/Gauteng
South Africa
Tel. +27 11 8300280
Fax +27 11 8300291

Far East

DORMA Far East Pte. Ltd.
No. 31 Gul Lane
Singapore 629425
Tel. +65 6268 7633
Fax +65 6265 7995

France

DORMA France S.A.S.
Europarc
42, rue Eugène Dupuis
F-94046 Créteil
Tel. +33 1 41942400
Fax +33 1 41942401

Gulf

DORMA Gulf Door Controls FZE
Jebel Ali Free Zone South
Plot No. S 20135
Road No. SW 301 G
P.O. Box 17268
Dubai – United Arab Emirates
Tel. +971 4 8020400
Fax +971 4 8869100/8869101

North America

DORMA Architectural Hardware
DORMA Drive, Drawer AC
Reamstown, PA 17567-0411
Tel. +1 800 5238483
Fax +1 800 2749724

Scanbalt

DORMA Sverige AB
F O Petersons Gata 24
SE-421 31 Västra Frölunda
Tel. +46 31 289520
Fax +46 31 281739

South America

DORMA Sistemas de Controles
para Portas Ltda.
Av. Piracema, 1400
Centro Empresarial Tambore
CEP 06400-933 Barueri/
São Paulo, Brasil
Tel. +55 11 46899280
Fax +55 11 46899215

South-East Europe

DORMA AUSTRIA GmbH
Pebering Strass 22
A-5301 Eugendorf
Tel. +43 6225 284880
Fax +43 6225 28491

South Europe

DORMA Italiana S.r.l.
Via. Canova 44/46
I-20035 Lissone (MI)
Tel. +39 039 244031
Fax +39 039 24403310

DORMA Ibérica, S.A.
Camino San Martin de la Vega, 4
E-28500 Arganda del Rey
(Madrid)
Tel. +34 91 8757850
Fax +34 91 8757881

UK/Ireland

DORMA UK Ltd.
Wilbury Way
Hitchin
GB-Hertfordshire SG4 0AB
Great Britain
Tel. +44 1462 477600
Fax +44 1462 477601